

SECTION A-A

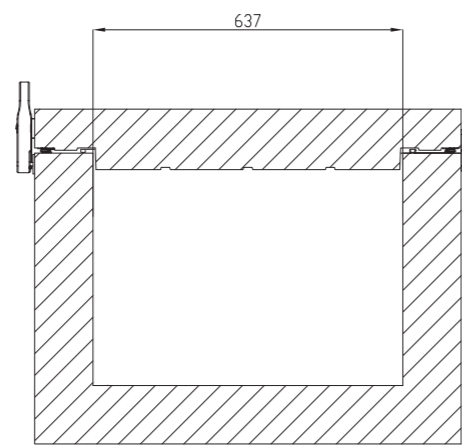

SECTION B-B

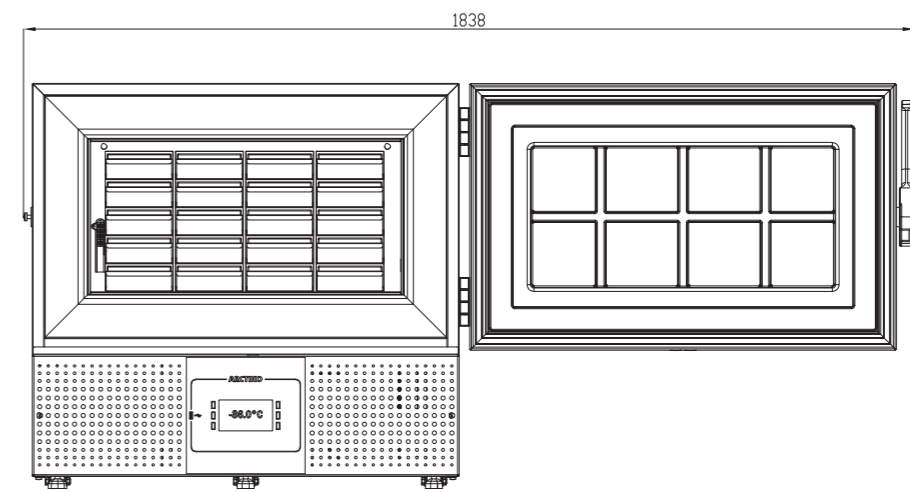
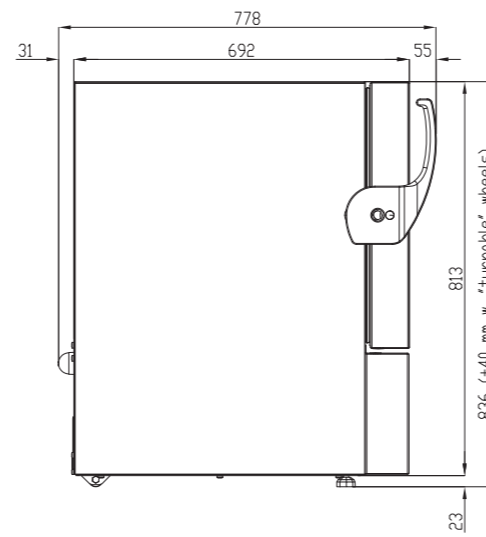
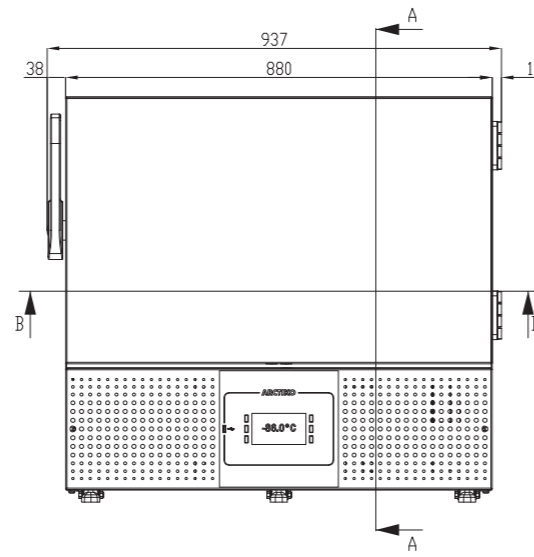
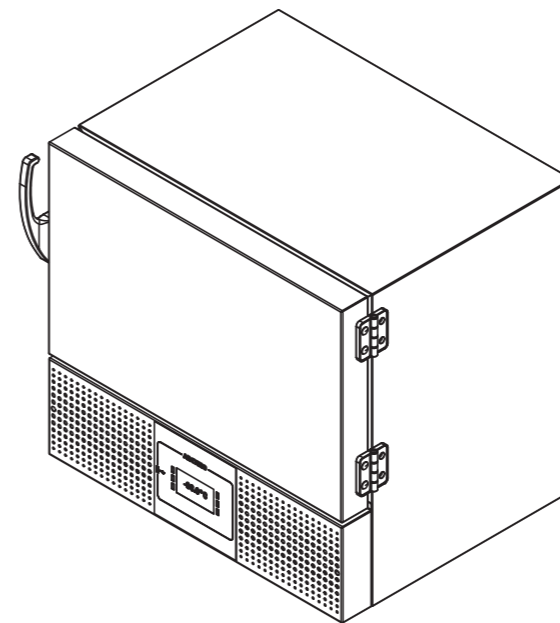

Description: Dimension drawing ULUF P90



Drawing no.: 5088170

Revision: 01

Drawing (initials): TTS

Date: 190616

Approval (initials): EAH

Date: 190617

All rights to this drawing belong to Arctiko A/S. The drawing may not be copied nor presented to any other person without prior written consent of Arctiko A/S.